

APP DOWNLOAD AND CONNECTION GUIDE



Search for Proscenic APP on App Store (IOS devices) or Google Play (Android devices). Or you could scan the QR Code below to download the APP.

Step 1:

Once the unit has been assembled, ensure that it is fully charged and press the power button to switch it on. Then press the Language/Mute button to switch to the local language (switching order: English, German, French, Italian, Spanish).

Note: The device can be connected to the internet when it's charging.

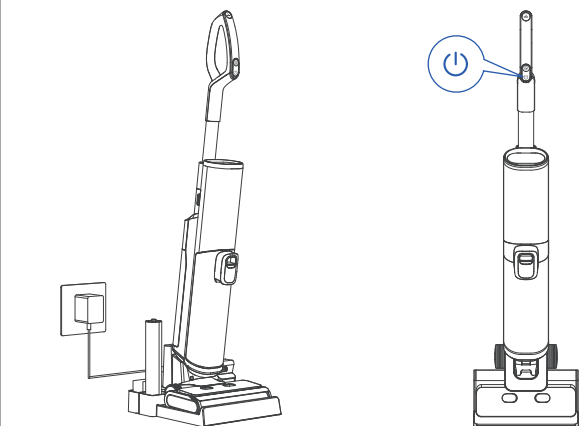

Step 2:

Press and hold the power button for 5 seconds to enter pairing mode or reset WiFi.

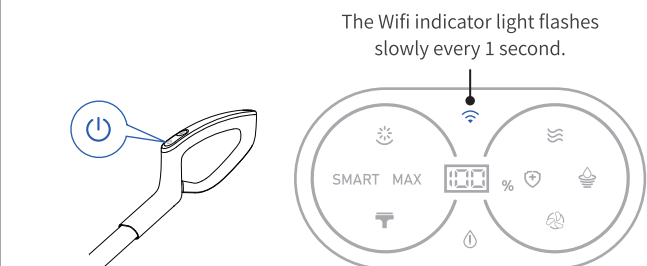

BLUETOOTH CONNECTION

Step 1:

Open the app, turn on Bluetooth and WiFi on your phone, search for nearby devices.

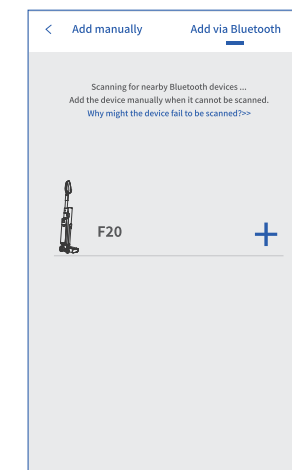

Step 3:

Connecting.

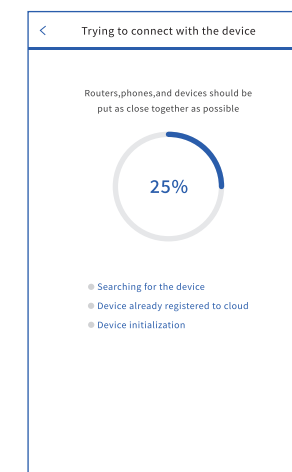

Step 2:

Select a network to connect your device. (Only 2.4G Wi-Fi networks are supported)

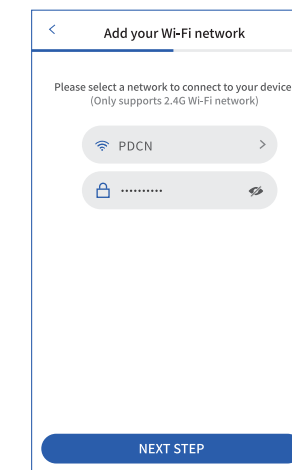

Step 4:

Connection is completed, start using the device. (The Wi-Fi light is always on in blue.)

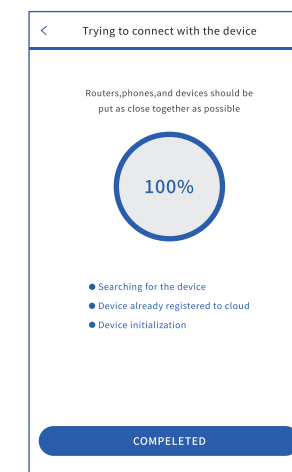

MANUAL CONNECTION

Step 1:

Select a network to connect your device. (Only 2.4G Wi-Fi networks are supported)

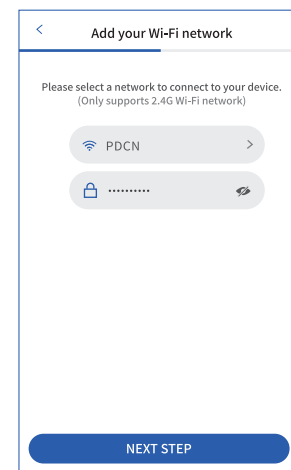

Step 3:

Connecting.

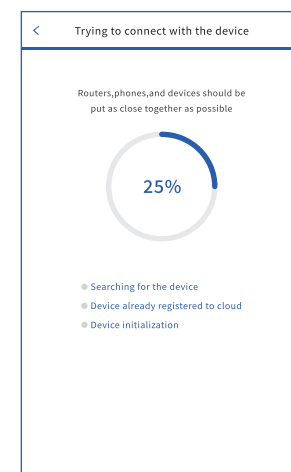

Step 2:

Go to Settings - WLAN list to connect to the device's hotspot "Proscenic-XXXX".

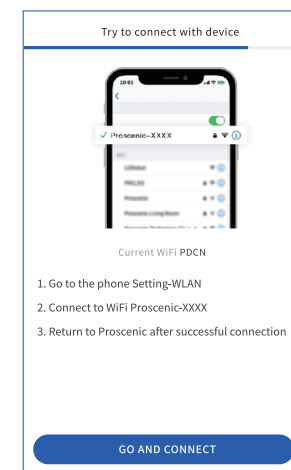

Step 4:

Connection is completed, start using the device. (The Wi-Fi light is always on in blue.)

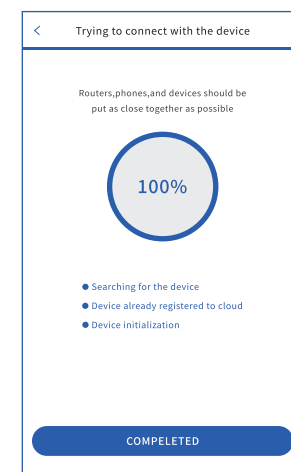

APP HERUNTERLADEN UND VERBINDUNGSANLEITUNG



Suchen Sie im App Store (IOS-Geräte) oder bei Google Play (Android-Geräte) nach Proscenic APP. Oder scannen Sie den QR-Code rechts, um die APP herunterzuladen.

Schritt 1:

Stellen Sie nach dem Zusammenbau des Geräts sicher, dass das Gerät über ausreichend Strom verfügt, und drücken Sie den Netzschalter, um es einzuschalten. Drücken Sie die Sprach-/Stummschalttaste erneut, um zur Landessprache zu wechseln (Umschaltreihenfolge: Englisch, Deutsch, Französisch, Italienisch, Spanisch).

Hinweis: Sie können sich während des Ladevorgangs direkt mit dem Internet verbinden.

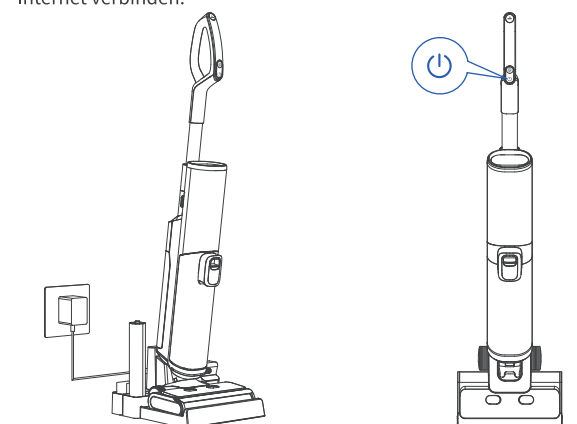

Schritt 2:

Halten Sie die die Ein/Aus-Taste 5 Sekunden lang gedrückt, um in den Paring-Modus zu wechseln oder das WLAN zurückzusetzen.

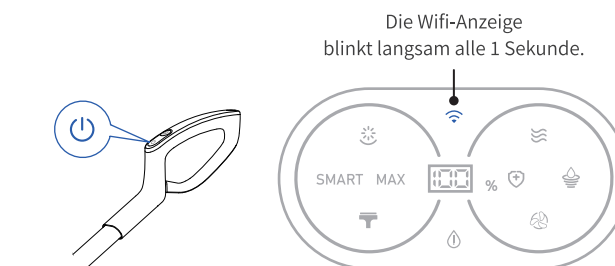

BLUETOOTH VERBINDUNG

Schritt 1:

Öffnen Sie die App, schalten Sie Bluetooth und WLAN auf Ihrem Handy ein und suchen Sie nach Geräten in der Nähe.



Schritt 3:

Verbinden.

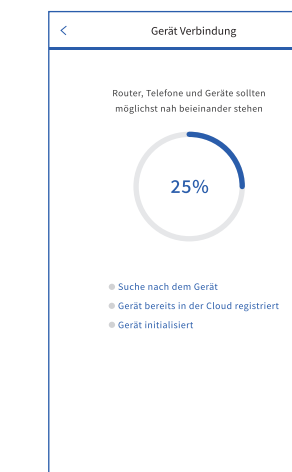

Schritt 2:

Wählen Sie ein Netzwerk aus, um Ihr Gerät zu verbinden. (Nur 2,4-G-WLAN-Netzwerke werden unterstützt)

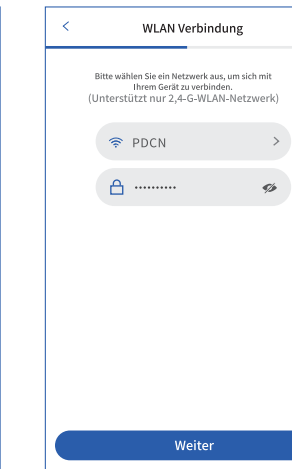

Schritt 4:

Verbindung erfolgreich, starten Sie die Reinigung. (Der Wi-Fi Indikator leuchtet immer in blau.)

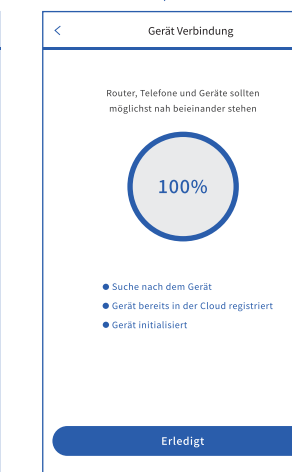

MANUELLE VERBINDUNG

Schritt 1:

Wählen Sie ein Netzwerk aus, um Ihr Gerät zu verbinden. (Nur 2,4-G-WLAN-Netzwerke werden unterstützt)

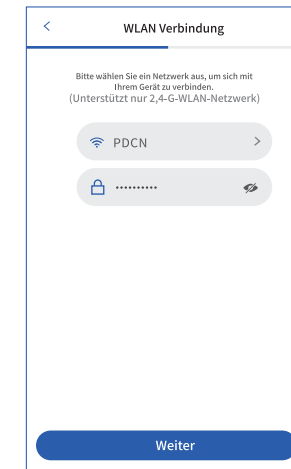

Schritt 3:

Verbinden.

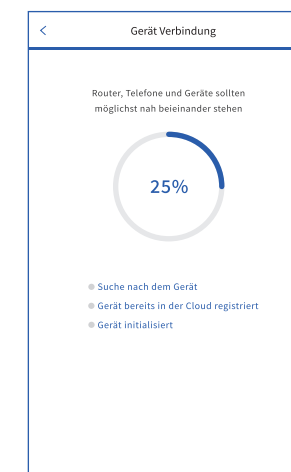

Schritt 2:

Gehen Sie zur Einstellungs-WLAN-Liste, um sich mit dem Hotspot des Geräts „Proscenic-XXXX“ zu verbinden.

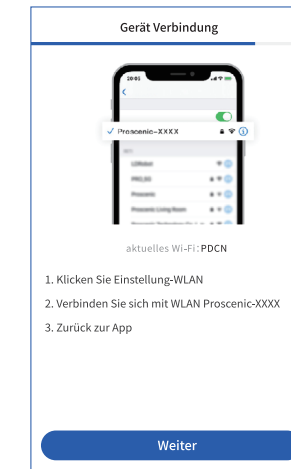

Schritt 4:

Verbindung erfolgreich, starten Sie die Reinigung. (Der Wi-Fi Indikator leuchtet immer in blau.)



GUIDE DE TÉLÉCHARGEMENT ET DE CONNEXION DE L'APP



Téléchargez l'application, recherchez "Proscenic" dans votre boutique d'applications mobiles. Téléchargez ou scannez le code QR pour vous inscrire et vous connecter.

Étape 1:

Une fois l'appareil assemblé, assurez-vous que l'appareil est entièrement chargé et appuyez sur le bouton d'alimentation pour l'allumer. Ensuite, appuyez sur le bouton Langue/Muet Passez à la langue locale (ordre de passage: anglais, allemand, français, italien, espagnol).

Remarque: l'appareil peut être connecté directement à Internet lorsqu'il est en charge.

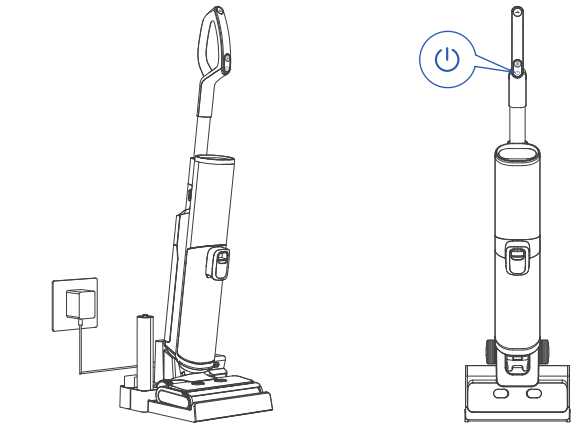

Étape 2:

Appuyez sur le bouton d'alimentation et maintenez-le enfoncé pendant 5 secondes pour entrer dans le mode de câblage ou réinitialiser le WiFi.

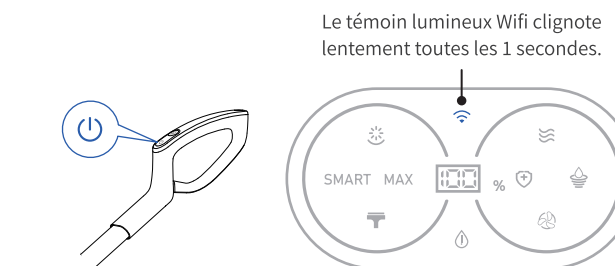

CONNECTIVITÉ BLUETOOTH

Étape 1:

Ouvrez l'application, activez le Bluetooth et le WiFi sur votre téléphone. Ensuite, recherchez les appareils à proximité.



Étape 3:

Le dispositif est connecté.

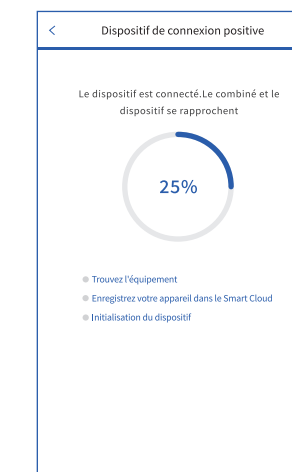

Étape 2:

Sélectionnez un réseau auquel connecter votre appareil. (Seuls les réseaux Wi-Fi 2.4G sont pris en charge)

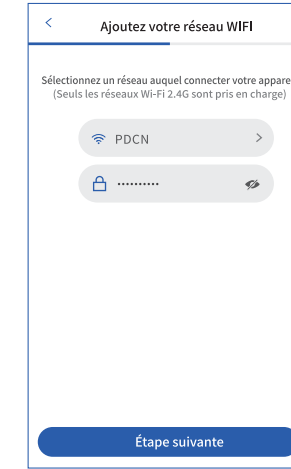

Étape 4:

La connexion est terminée et vous pouvez commencer à utiliser l'appareil. ((Lumière Wi-Fi toujours allumée en bleu))



CONNEXION MANUELLE

Étape 1:

Sélectionnez un réseau auquel connecter votre appareil. (Seuls les réseaux Wi-Fi 2.4G sont pris en charge)

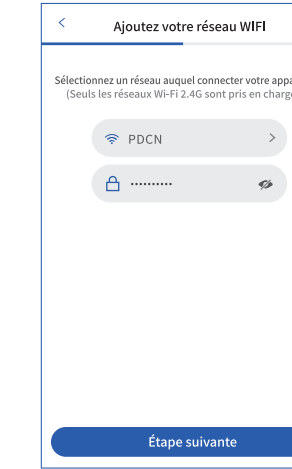

Étape 3:

Le dispositif est connecté.

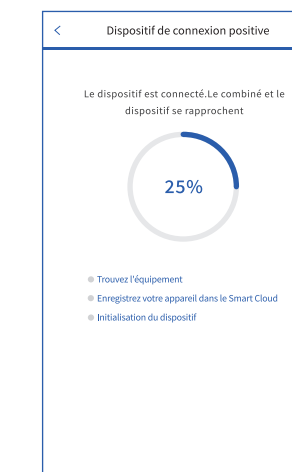

Étape 2:

Allez dans Paramètres - Liste WLAN pour vous connecter à l'ordinateur. le hotspot de l'appareil "Proscenic-XXXX".

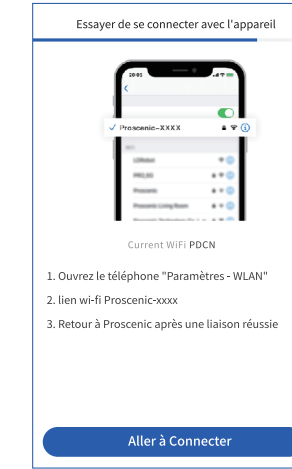

Étape 4:

La connexion est terminée et vous pouvez commencer à utiliser l'appareil. ((Lumière Wi-Fi toujours allumée en bleu))



GUIDA AL DOWNLOAD E ALLA CONNESSIONE DELL'APP



Cerca Proscenic APP su App Store (dispositivi IOS) o Google Play (dispositivi Android). Oppure puoi scansionare il codice QR sulla destra per scaricare l'APP.

Passo 1:

L'unità è stata assemblata, assicurarsi che sia completamente carica e premere il pulsante di accensione per accenderla. Quindi premere il pulsante Language/Mute per passare alla lingua locale (ordine di commutazione: inglese, tedesco, francese, italiano, spagnolo).

Nota: Il dispositivo può essere collegato a Internet quando è in carica.

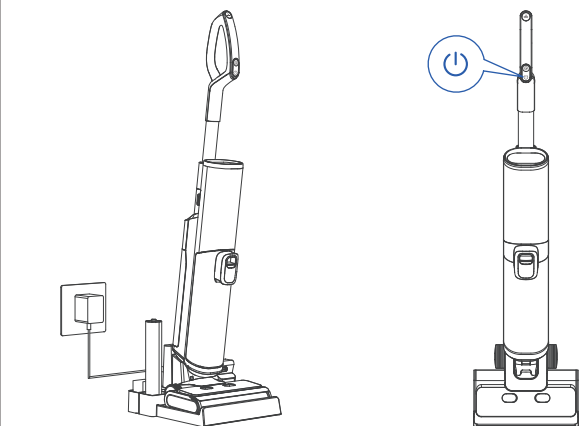

Passo 2:

Tenere premuto il pulsante di accensione per 5 secondi per entrare in modalità di accoppiamento o ripristinare il WiFi.

L'indicatore WiFi lampeggia lentamente in bianco una volta al secondo.

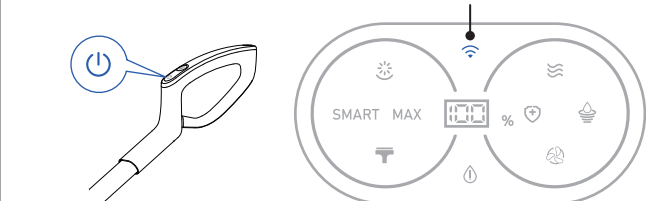

CONNESSIONE BLUETOOTH

Passo 1:

Aprire l'applicazione, accendere il Bluetooth e il WiFi sul telefono, cercare i dispositivi vicini.

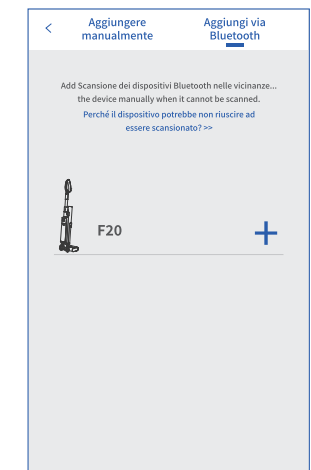

Passo 3:

Collegare.

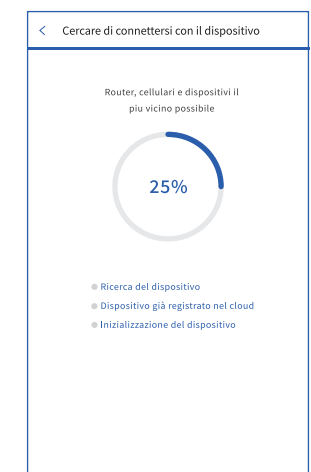

Passo 2:

Seleziona una rete a cui collegare il tuo dispositivo. (Supporta solo reti WiFi 2.4G)

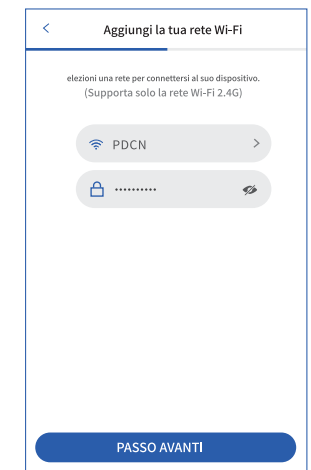

Passo 4:

La connessione è completata, inizia ad usare il dispositivo. (L'indicatore Wi-Fi è sempre accesa in blu).

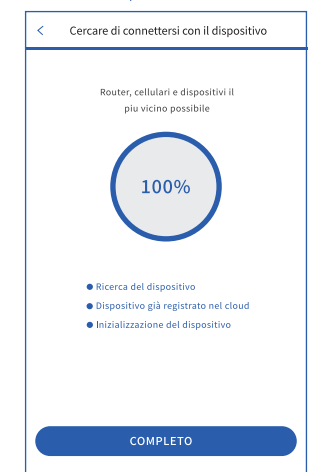

COLLEGAMENTO MANUALE

Passo 1:

Seleziona la rete a cui collegare il tuo dispositivo. (Supporta solo reti WiFi 2.4G)

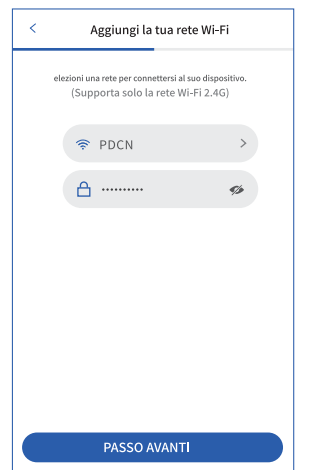

Passo 3:

Collegare.

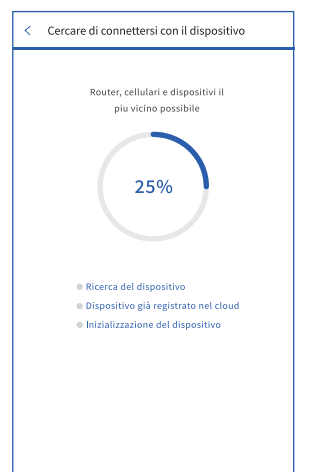

Passo 2:

Vai su Impostazioni - Elenco WLAN per connetterti all'hotspot del dispositivo "Proscenic-XXXX".

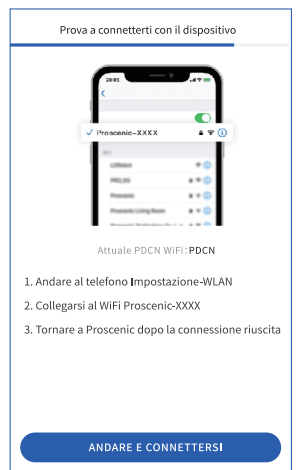

Passo 4:

La connessione è completata, inizia ad usare il dispositivo. (L'indicatore Wi-Fi è sempre accesa in blu).



DESCARGA DE LA APLICACIÓN Y GUÍA DE CONEXIÓN



Busque la APP de Proscenic en App Store (dispositivos IOS) o Google Play (dispositivos Android). O puede escanear el siguiente código QR para descargar la APP.

Paso 1:

Una vez montado el equipo, asegúrese de que está completamente cargado y pulse el botón de encendido para ponerlo en marcha. A continuación, pulse el botón de idioma/silencio para cambiar al idioma local (orden de conmutación: inglés, alemán, francés, italiano, español).

Nota: El aparato puede conectarse a Internet cuando se está cargando.

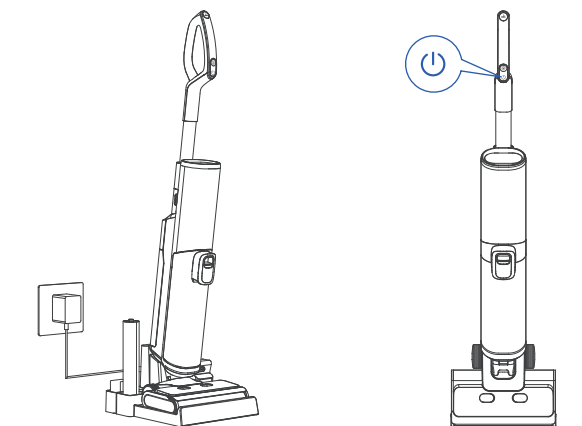

Paso 2:

Mantenga presionado el botón de encendido durante 5 segundos para ingresar al modo de configuración de red o restablecer el WiFi.

La luz indicadora de Wifi parpadea lentamente cada 1 segundo.

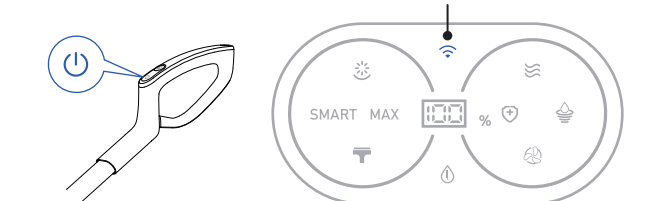

CONEXIÓN BLUETOOTH

Paso 1:

Abre la APP, activa el Bluetooth y el WiFi en su móvil, busca los dispositivos cercanos.



Paso 3:

Conectando.

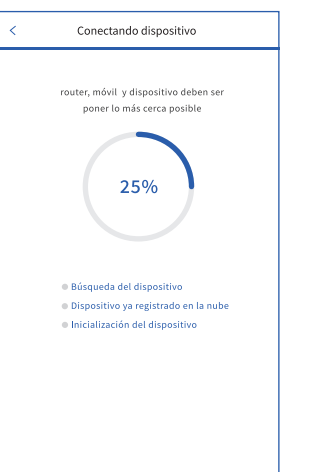

Paso 2:

Selecione una red a la que conectar su dispositivo. (Solo se admiten redes Wi-Fi 2.4G)

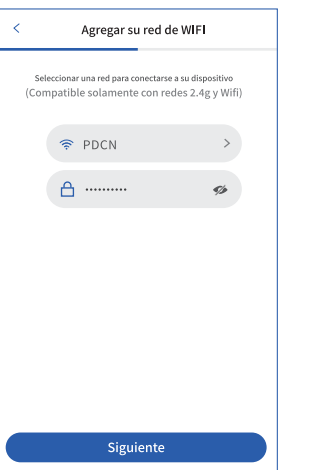

Paso 4:

La conexión se ha completado. (La luz de Wi-Fi está siempre encendida en azul)

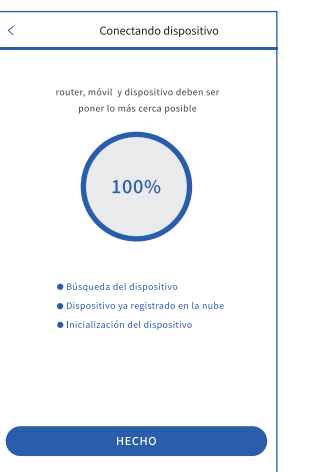

CONEXIÓN MANUAL

Paso 1:

Selecione una red a la que conectar su dispositivo. (Solo se admiten redes Wi-Fi 2.4G)

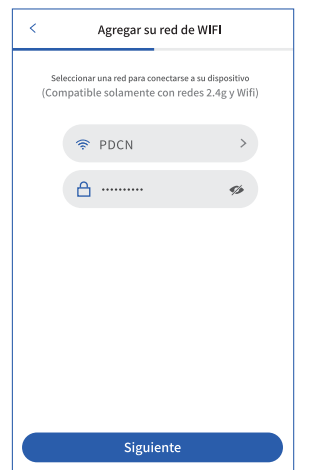

Paso 3:

Conectando.

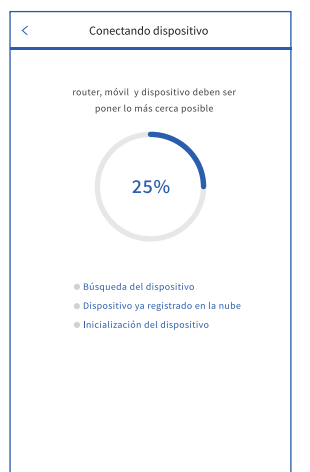

Paso 2:

Vaya a Configuración - Lista WLAN para conectarse al hotspot del dispositivo "Proscenic-XXXX".



Paso 4:

La conexión se ha completado. (La luz de Wi-Fi está siempre encendida en azul)



アプリダウンロードとインターネット設定マニュアル



アプリのダウンロード、スマホアプリストアで“Proscenic”検索、或はQRコードをスキャン、登録、ログイン。

第一歩:

デバイスが組み立てた後、バッテリー残量を確認し、電源ボタンを押して起動（充電中、オフの状態でもネットを接続できる）。

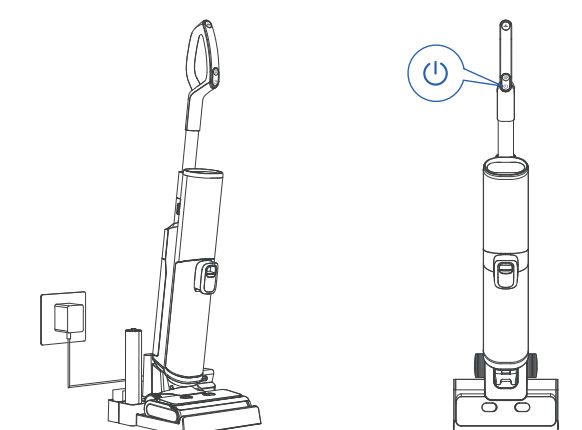

第二歩:

電源ボタンを5秒押し、インターネット設定モード或はWiFiリセット。

白いWiFiランプ点滅、一秒一回

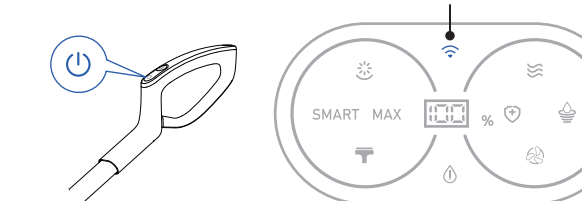

BLUETOOTH ペアリング

第一歩:

アプリ起動、スマホのBluetooth機能とWiFi機能開いて、近くのデバイスを探す。



第三歩:

デバイス接続中

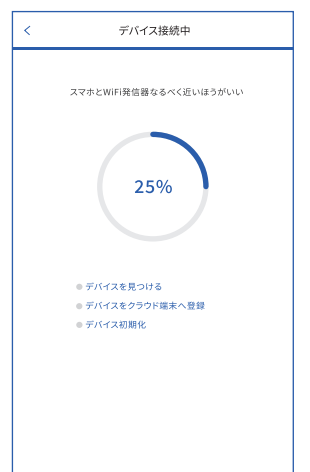

第二歩:

一つのWiFiを選んでデバイスと繋ぐ。(2.4Gしか支持できません)

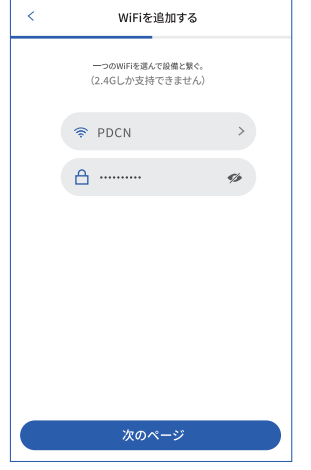

第四歩:

接続完了、デバイス使用可能。(青いWiFiランプ点灯)

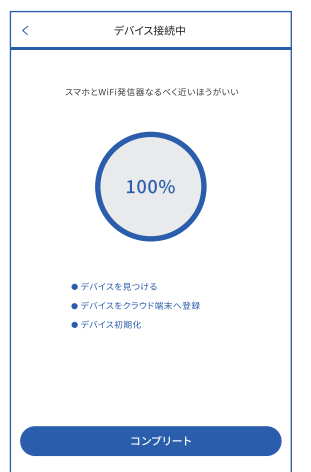

手動で接続

第一歩:

一つのWiFiを選んでデバイスと繋ぐ。(2.4Gしか支持できません)

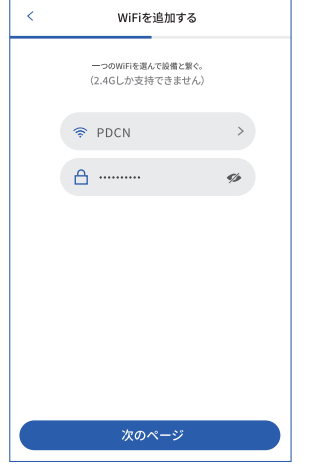

第三歩:

デバイス接続中

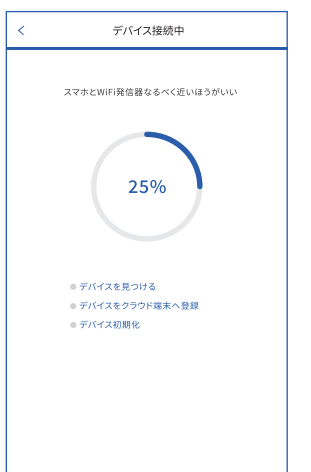

第二歩:

<設定>-WLAN中のデバイスのホットスポット“Proscenic-xxxx”を選択。

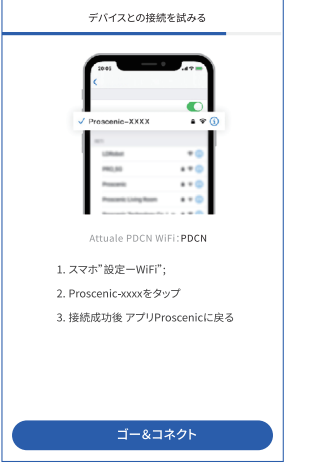

第四歩:

接続完了、デバイス使用可能。(青いWiFiランプ点灯)





PROSCENIC

F20 APP 说明书 通用

Design Date: 2022-04-07

物料编码

成品尺寸

200*95mm / 风琴折

工 艺

不过膜

材 质

128G铜版纸

印刷要求

4C双面印刷

版 本

V1.11